

METAL CEILINGS

Simplicity, Slim & Streamline Baffles

FEATURES AND BENEFITS

- Simple design provides easy access to enclosed plenums
- 3 profiles to select from
- Available in numerous colours
- Choose from a range of heights which can be installed at varied spacings
- Can be installed on either vertical or curved surfaces
- End caps are matched to the colour of your choice

APPLICATIONS

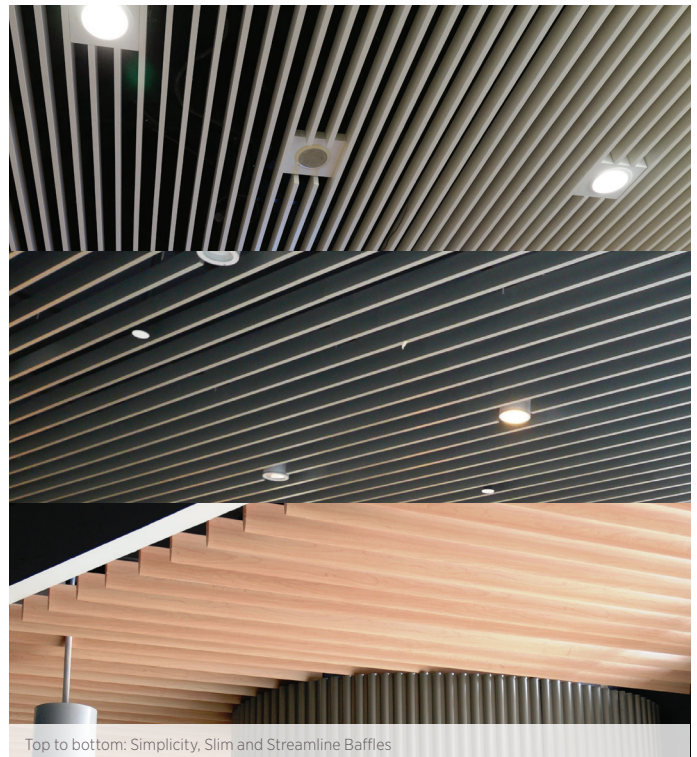

- Entertainment venues such as gaming lounges
- Lobbies or foyers
- Offices
- Restaurants
- Retail areas
- Transportation centres, including train stations and airport terminals



Top to bottom: Simplicity, Slim and Streamline Baffles

COLOURS

Due to printing limitations, shade may vary from actual product.

 2113 Standard White	 3111 Black	 5113 Silver	 5114 Copper	 5115 Dark Bronze	 5117 Gold
 3126 Grass Green	 3112 Orange	 3117 Red	 2122 Yellow Lemon	 3116 Sky Blue	 5119 Hammer Silver Black
 WD-8010 Atlantic Cedar	 WD-8002 Natural Oak	 WD-8006 Dark Ash	 WD-8014 California Nut	 WD-8015 Maple Wood	 WD-8026 Africa Beech

Over 44 colour and 26 wood look options to choose from, refer to USG BORAL Series 2000/5000 and Wood Look Aluminium Metal Ceilings Colour Guide.

SIMPLICITY, SLIM & STREAMLINE BAFFLES

METAL CEILINGS

10 Year Warranty¹

PRODUCT INFORMATION

Baffle Options	Dimensions	Item No.	Item Name	Diagram Reference No.
W 25mm x H 35mm		DRALSI2515036002113	Simplicity Baffle 25mm x 150mm x 3600mm	1
W 25mm x H 50mm		DRALSIEC251502113	Simplicity End Cap 25mm x 150mm	5
W 25mm x H 75mm		DRALSIPC251502113	Simplicity Panel Connector 25mm x 150mm	6
W 25mm x H 100mm		DRALSNB	Baffle Bracket	2
W 25mm x H 150mm		DRALCR	Baffle Carrier 3000mm	3
W 30mm x H 100mm		DRALCRC	Baffle Carrier Connector	4
		CL2424	Suspension Hanger	8
		CW253625	Ceiling Wire Gal 2.5 x 3600	7
W 15mm x H 50mm		DRALSL1510036002113	Slim Baffle 15mm x 100mm x 3600mm (White)	
W 15mm x H 75mm		DRALSLEC151002113	Slim End Cap 15mm x 100mm (White)	
W 15mm x H 100mm		DRALSLPC151002113	Slim Panel Connector 15mm x 100mm (White)	
W 15mm x H 150mm		DRALSL1510036003111	Slim Baffle 15mm x 100mm x 3600mm (Black)	
		DRALSLEC151003111	Slim End Cap 15mm x 100mm (Black)	
		DRALSLPC151003111	Slim Panel Connector 15mm x 100mm (Black)	
		DRALSNB	Baffle Bracket	2
		DRALCR	Baffle Carrier 3000mm	3
		DRALCRC	Baffle Carrier Connector	4
		CW253625	Ceiling Wire Gal 2.5 x 3600	7
W 25mm x H 50mm		DRALST2510036008010	Streamline Baffle 25mm x 100mm x 3600mm (Atlantic Cedar)	
W 25mm x H 75mm		DRALSTEC251008010	Simplicity End Cap 25mm x 100mm	
W 25mm x H 100mm		DRALSTPC251008010	Streamline Panel Connector 25mm x 100mm	
W 25mm x H 150mm		DRALSNB	Baffle Bracket	2
		DRALCR	Baffle Carrier 3000mm	3
		DRALCRC	Baffle Carrier Connector	4
		CW253625	Ceiling Wire Gal 2.5 x 3600	7

SIMPLICITY BAFFLES

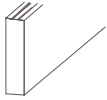

SLIM BAFFLES

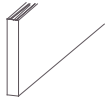

STREAMLINE BAFFLES

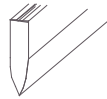

Minimum lead times apply, check with USG Boral for availability

¹ 10 Year Warranty on Indoor Panels only
USG Boral Metal Ceiling Panels are covered by a 10 year warranty when used indoors and 5 years outdoors. Go to USGBoral.com/Baffles for Metal Ceiling Warranty CW2015B.

SIMPLICITY, SLIM & STREAMLINE BAFFLES

METAL CEILINGS

SUSPENSION METHODS

FOR SEISMIC DESIGN SUPPORT PLEASE CONTACT TecASSIST™

SIMPLICITY PROFILE SUSPENDED WITH (7) CEILING WIRE

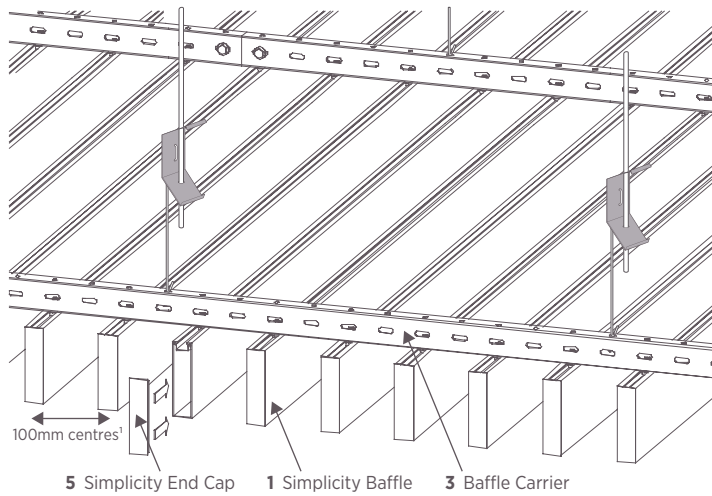

¹Baffle spacing is 50mm minimum, typical spacing as shown with Simplicity 25mm W x 100mm H Baffle

SECTION OF CARRIERS

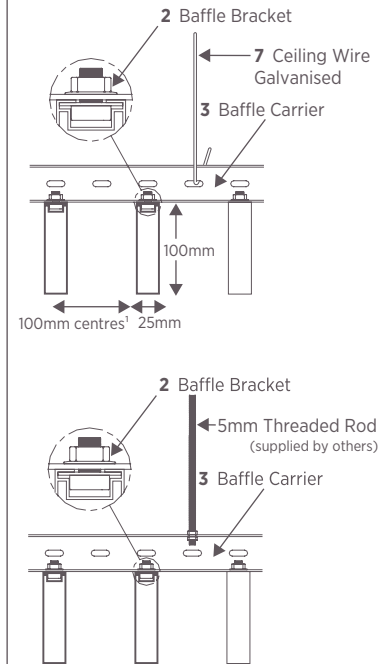

SIMPLICITY PROFILE SUSPENDED WITH 5MM ROD

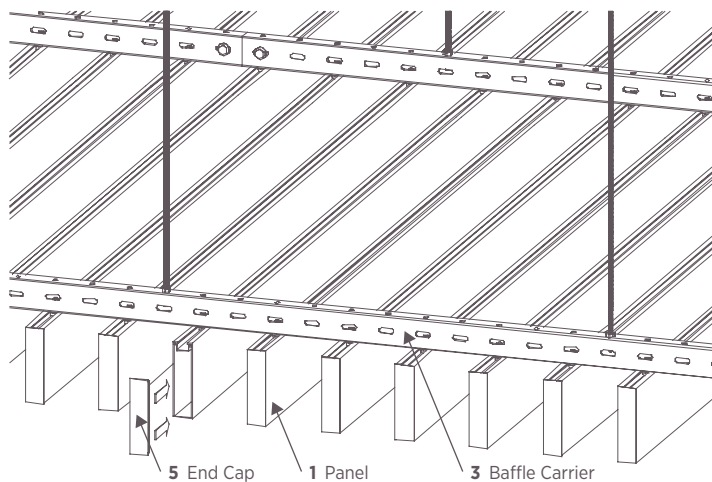

CONNECTION DETAIL

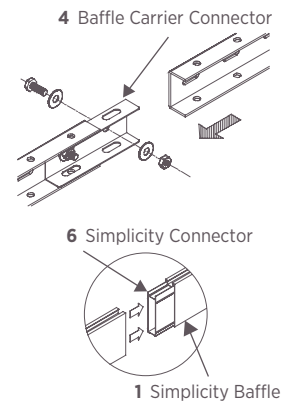

The ceiling is suspended from either Ceiling Wire Galvanised **(7)** or 5mm Threaded Rods that connect with Baffle Carriers **(3)** at 1200mm max. The Baffles are typically installed perpendicular to the Baffle Carriers **(3)** at 100mm centres (minimum 50mm) using Baffle Brackets **(2)**. The Baffle Carrier Connectors **(4)** are mechanically fastened to connect the Baffle Carriers **(3)**. Panel Connector **(6)** are used to connect the Baffles **(1)**.

PHYSICAL DATA/ FOOTNOTES

Material

Baffles are made from extruded aluminium. Carrier Rails are made from galvanised steel and are powder coated black.

Finishing

Electrostatically applied polyester powder coating. Thickness of coating shall be min 60 microns. The powder coating has a 5 years outdoor and 10 years indoor warranty.

Properties	Standards	Performance
Impact Resistance Test	ASTM D 2794 16mm ball	9 Nm
Erichsen Cupping Test	DIN EN ISO 1520	5 - 10mm
Bend Test	DIN EN ISO 1519	3 - 12mm
Pencil Hardness Test	ASTM D3363	HB - 2H
Buchholz	DIN EN ISO 2815	70 - 90
Adhesion	DIN EN ISO 2409	Gt0 - no loss of adhesion
Corrosion Protection	ASTM B117-73	Excellent
QUV Resistance	ASTM 6 - 53	Excellent
Surface Spread of Flame	BS476: part 7 - 1997	Class 1
Fire Propagation Test	AS/NZS 3837 ISO 5560	Group 1 - unsprinkled Group 1 - S
Chlorine Exposure Test	Excellent	

Tolerances

All ceiling should conform to BS8290, Dimensional Accuracy Test.

Warranty

USG Boral Metal Ceiling Panels are covered by a 10 year warranty when used indoors and 5 years outdoors. Go to USGBoral.com/baffles for Metal Ceiling Warranty CW2015B.

System Weights

Including Carrier Rail spaced at 1200mm centres and Baffles at 100mm centres:

Simplicity

1. W 25mm x H 35mm at 100mm centres: 8.23kgs/m²
2. W 25mm x H 50mm at 100mm centres: 8.40kgs/m²
3. W 25mm x H 75mm at 100mm centres: 9.69kgs/m²
4. W 25mm x H 100mm at 100mm centres: 11.43kgs/m²
5. W 25mm x H 150mm at 100mm centres: 17.98kgs/m²
6. W 30mm x H 100mm at 100mm centres: 11.34kgs/m²

Streamline

1. W 25mm x H 50mm at 100mm centres: 8.28kgs/m²
2. W 25mm x H 75mm at 100mm centres: 9.61kgs/m²
3. W 25mm x H 100mm at 100mm centres: 10.87kgs/m²
4. W 25mm x H 150mm at 100mm centres: 17.50kgs/m²

Slim

1. W 25mm x H 50mm at 100mm centres: 7.24kgs/m²
2. W 25mm x H 75mm at 100mm centres: 8.66kgs/m²
3. W 25mm x H 100mm at 100mm centres: 9.89kgs/m²
4. W 25mm x H 150mm at 100mm centres: 17.44kgs/m²

SALES ENQUIRIES **1800 226 215** (AU) **0800 USGBORAL** (NZ)



© 2016 USG BORAL. All rights reserved.

Manufactured, sold or distributed by USG Boral Building Products or one or more of its affiliates. INNOVATION INSPIRED BY YOU and DONN are trademarks of USG Boral Building Products or one or more of its affiliates. The trademarks CENTRICITEE, DX, DXF, DXT, RADAR, CLIMAPLUS and FINELINE are trademarks of USG Interiors LLC and used under license.

This technical information is intended to provide general information on plasterboard products and should not be a substitute for professional building advice. We recommend you use a qualified person to install USG Boral plasterboard. Illustrations in this guide are only representative of USG Boral plasterboard products and the appearance and effects that may be achieved by their use. To ensure the information you are using is current, USG Boral recommends you review the latest building information available on the USG Boral website USGBoral.com. Product availability should be checked with your local USG Boral Sales Office, as available may vary.

Safety First! Follow good safety/industrial hygiene practices during installation. Wear appropriate personal protective equipment. Read SDS and literature before specification and installation.

USG Boral Building Products Pty Limited - ABN 84 004 231 976 251 Salmon Street, Port Melbourne, Vic. 3207

UB1011-2